

Technical Data Sheet

Part Number: MTXB-2835XB-MMA TOP LED, Working Current @ IF = 60mA /150mA

产 品 规 格 书
SPECIFICATION

客户名称 Customer		产品型号 Type	MTXB-2835XB-MMA
客户型号 Customer No.		ERP编码 ERP No.	

客 户 确 认 APPROVED SIGNATURES			

研 究 开 发 中 心 Research & Development Center		
批 准 APPROVE	审 核 CHECK	制 定 DRAW
版本号(Version NO.): A0		
文件发放日期(Release Date): 2015-12-11		

※ 确认后请回传至 0755-33910220。 Please confirm and fax back to us at 86-755-33910220.

※ 本页仅供客户确认产品规格，如需详细的规格书，请登录我公司网站下载。

This page is only for confirming the part No., for specific data sheet please download from our website at <http://www.bmtcled.com>

Technical Data Sheet

Part Number: MTXB-2835XB-MMA TOP LED, Working Current @ IF = 60mA /150mA

Part No. Description 产品型号说明

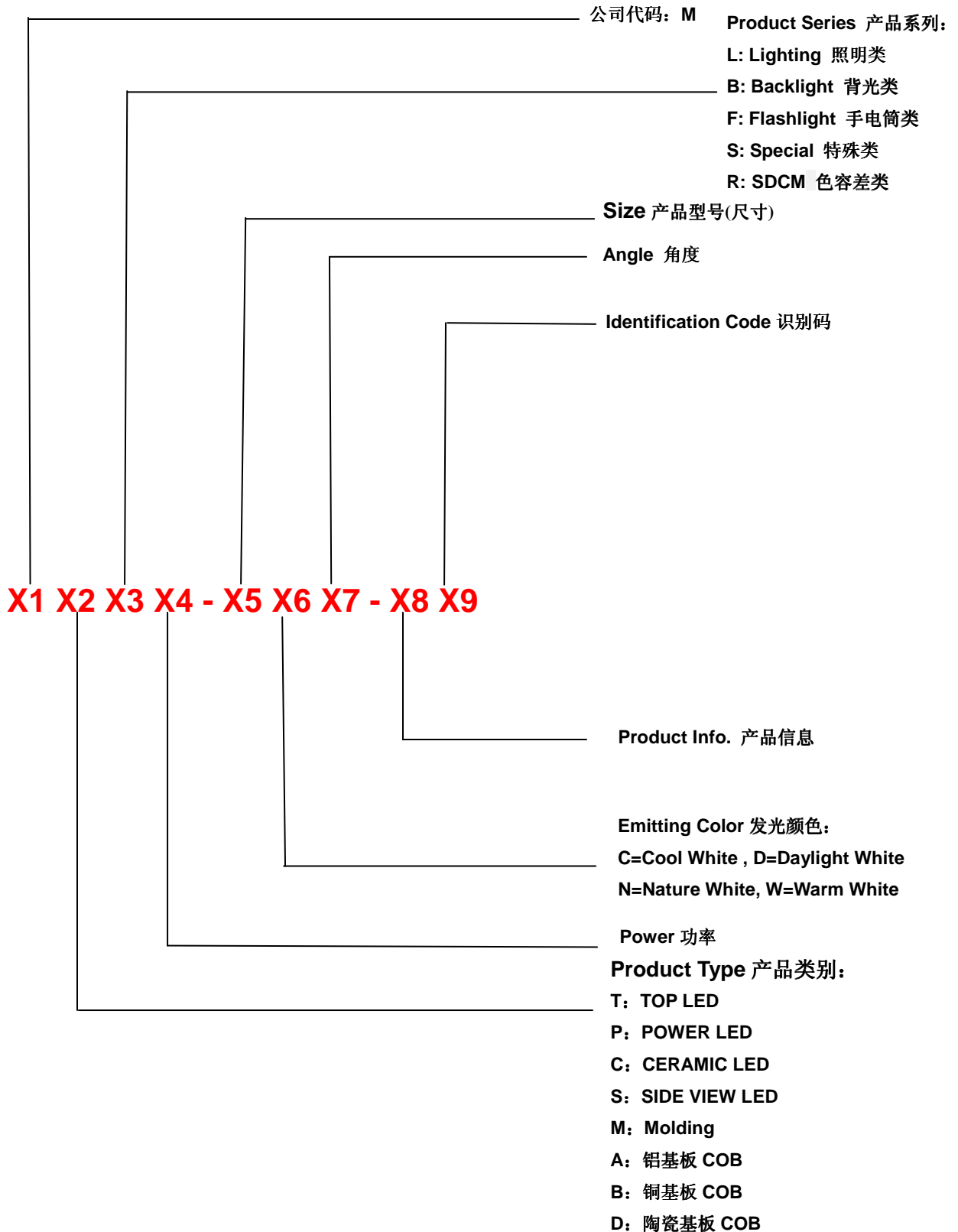

Technical Data Sheet

Part Number: MTXB-2835XB-MMA TOP LED, Working Current @ IF = 60mA /150mA

Features

- Package Size: 3.5 (L) x2.8(W) x 0.65 (T) mm
- Silicone Packed
- Suitable for different working environment
- Super long lifetime: 30000HRs
- Anti UV
- White colors are available in (2600K- 7000K)
- Wide viewing angle ($2\theta_{1/2}=120^\circ$)

产品特征

- 封装尺寸: 3.5 (长) x2.8(宽) x0.65 (厚) mm
- 采用硅胶封装
- 适应多种工作环境
- 超长寿命: 30000 小时
- 防紫外线
- 可供白光(2600K-7000K)
- 宽角度 ($2\theta_{1/2}=120^\circ$)



Device Selection Guide 物料选用指南

ITEM 项目	MATERIALS 物料
Resin 胶体	Silicone 硅胶
Lens Color 胶体颜色	Yellow 黄色
Dice 晶片	InGaN

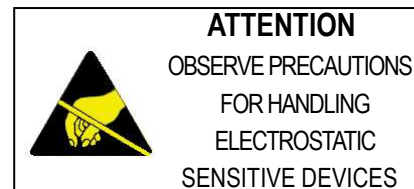

Applications

- **Indoor lighting:** Fluorescent lamp, tube
- **Commercial illumination and displays:** Advertising words, light box
- **Decorative lighting:** light strip
- **Automotive interior auxiliary lighting**
- **Other illumination and displays**

产品应用

- **室内照明:** 日光灯管、灯条
- **商业照明显示:** 广告字、广告灯箱
- **装饰照明:** 柔性灯条
- **汽车内部辅助照明**
- **其它照明和显示类**

Technical Data Sheet

Part Number: MTXB-2835XB-MMA TOP LED, Working Current @ IF = 60mA/150mA

Package Outline Dimensions 封装外形尺寸

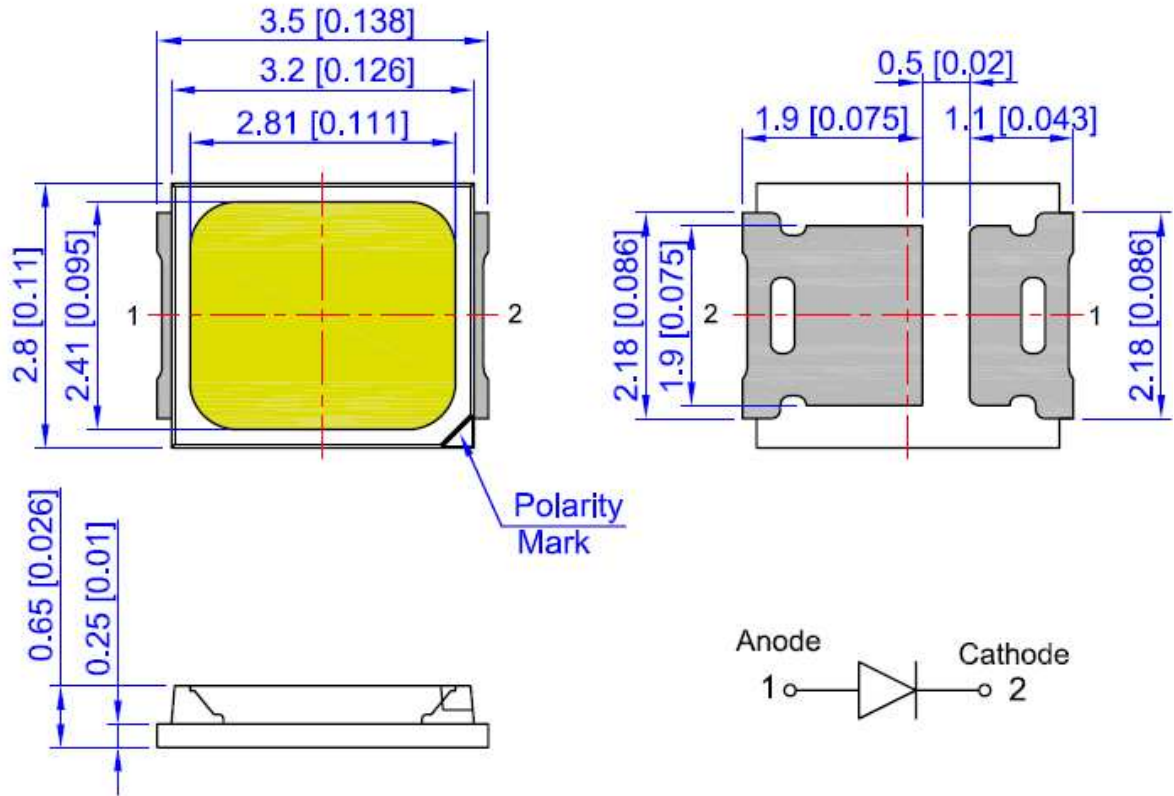

Recommended solder pad for MTXB-2835 series
建议用于 MTXB-2835 系列的焊盘

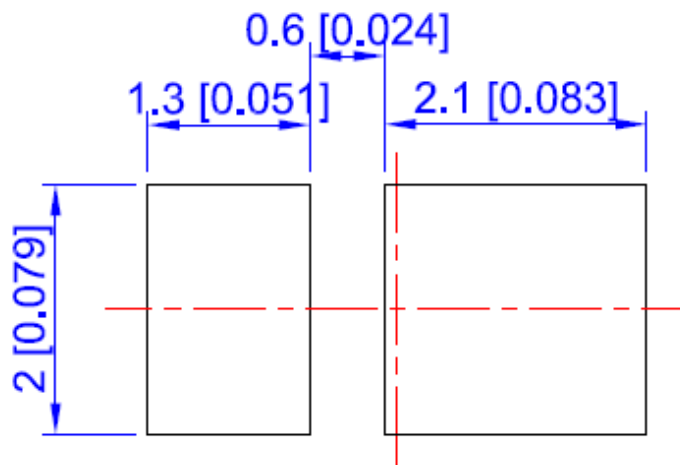

Note: 1. UNIT: MM [INCH]. 单位: 毫米[英寸]

2. The tolerances unless mentioned is ± 0.2 mm. 除非另有说明, 以上尺寸的公差为 ± 0.2 mm。

Technical Data Sheet

Part Number: MTXB-2835XB-MMA TOP LED, Working Current @ IF = 60mA/150mA

Absolute Maximum Ratings 极限参数(Ta=25°C)

Parameter 参数	Symbol 符号	Rating 额定值	Unit 单位
Reverse Voltage 反向电压	V _R	5	V
Forward Current 正向电流	I _F	150	mA
Operating Temperature 工作温度	Topr	-40 ~ +80	°C
Storage Temperature 储存温度	Tstg	-40 ~ +80	°C
Soldering Temperature 焊接温度	Tsol	260(for 5 seconds)	°C
Junction Temperature 结点温度	T _j	115	°C
Power Dissipation 功耗	P _d	450	mW

Electro-Optical Characteristics 光电特性 (Ta=25°C)

Parameter 参数	Symbol	Min.	Typ.	Max.	Unit	Condition 条件
Viewing Angle 角度	2θ1/2	-----	120	-----	deg	If=150mA
Reverse Current 反向电流	I _R	-----	-----	50	μA	VR=5V

Technical Data Sheet

Part Number: MTXB-2835XB-MMA TOP LED, Working Current @ IF = 60mA/150mA

Bin Code of Luminous Flux 光通量等级代码

Luminous Flux Code 光通量代码	Luminous Flux Range 光通量范围 (lm)		CCT (K) (typ)	CRI (min.)	Current (mA)
	Min.	Max.			
203	24	26	2700	80	60
204	26	28			
203	24	26	3000	80	60
204	26	28			
204	26	28	4000	80	60
205	28	30			
204	26	28	5000	80	60
205	28	30			
204	26	28	6000	80	60
205	28	30			
204	26	28	6500	80	60
205	28	30			

Luminous Flux Code 光通量代码	Luminous Flux Range 光通量范围 (lm)		CCT (K) (typ)	CRI (min.)	Current (mA)
	Min.	Max.			
501	50	55	2700	80	150
502	55	60			
501	50	55	3000	80	150
502	55	60			
502	55	60	4000	80	150
601	60	65			
502	55	60	5000	80	150
601	60	65			
502	55	60	6000	80	150
601	60	65			
502	55	60	6500	80	150
601	60	65			

Note: Tolerance of Luminous Flux is $\pm 10\%$. 光通量的公差为 $\pm 10\%$ 。

Technical Data Sheet

Part Number: MTXB-2835XB-MMA TOP LED, Working Current @ IF = 60mA/150mA

White Bin Code of CIE1931 白光 CIE 分级代码

TOP LED 色区汇总图(大BIN色区)

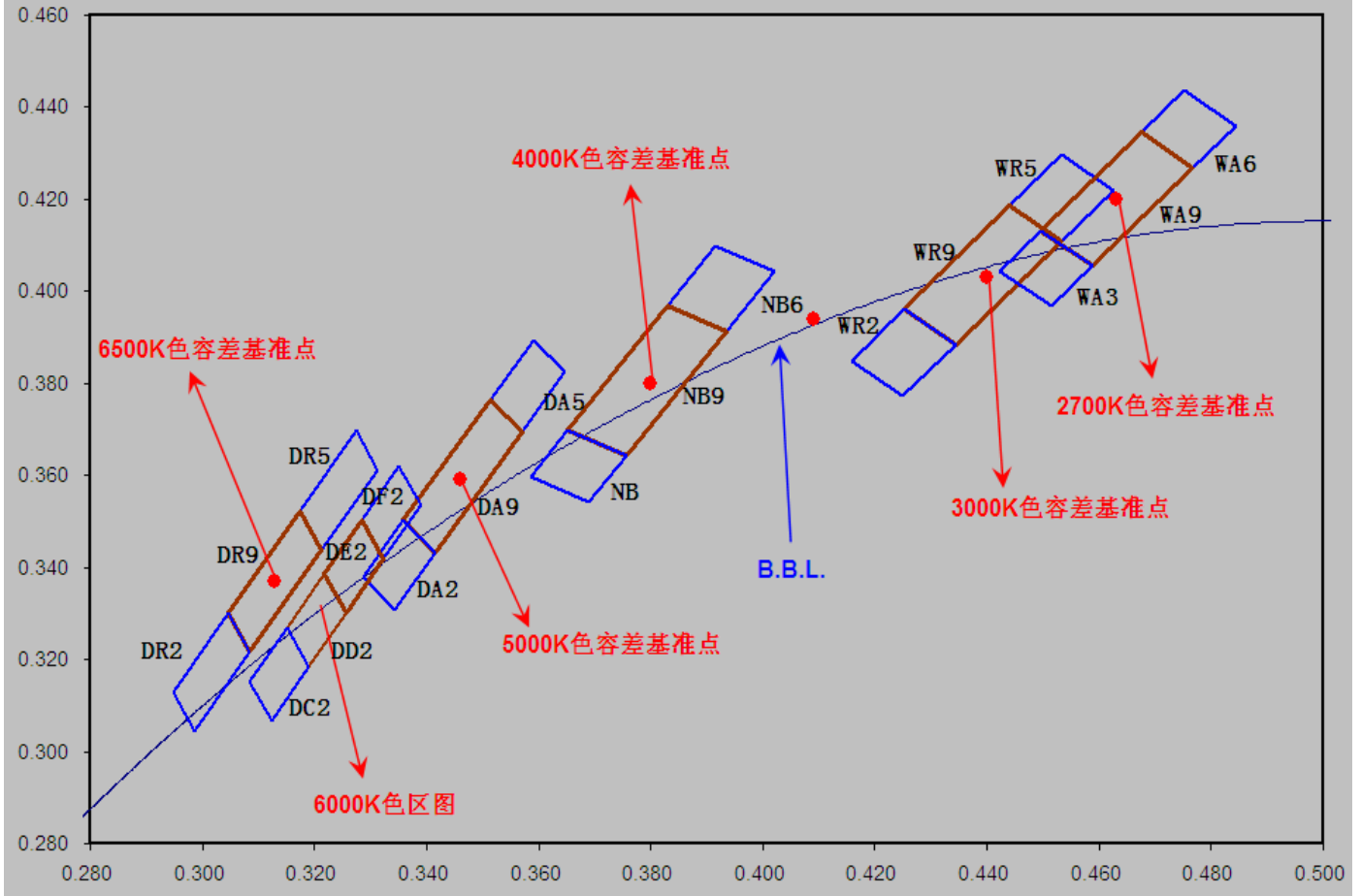

Technical Data Sheet

Part Number: MTXB-2835XB-MMA TOP LED, Working Current @ IF = 60mA/150mA

Color coordinates 颜色坐标

编 码	Code	X	Y	编 码	Code	X	Y	编 码	Code	X	Y	编 码	Code	X	Y
639	DR5	0.3275	0.3697	641	DR9	0.3174	0.3522	636	DR2	0.3047	0.3302	/	/	/	/
		0.3174	0.3522			0.3047	0.3302			/	/				
		0.3212	0.3437			0.3085	0.3217			/	/				
		0.3313	0.3612			0.3212	0.3437			/	/				
606	DF2	0.3351	0.3619	607	DE2	0.3284	0.3502	608	DD2	0.3218	0.3386	609	DC2	0.3151	0.3269
		0.3284	0.3502			0.3218	0.3386			0.3151	0.3269				
		0.3323	0.3418			0.3256	0.3301			0.319	0.3184				
		0.3389	0.3535			0.3323	0.3418			0.3256	0.3301				
504	DA5	0.359	0.3894	505	DA9	0.3513	0.3765	501	DA2	0.3358	0.3502	/	/	/	/
		0.3513	0.3765			0.3358	0.3502			0.3286	0.3379			/	/
		0.357	0.3695			0.3415	0.3432			0.3343	0.3309			/	/
		0.3647	0.3824			0.357	0.3695			0.3415	0.3432			/	/
405	NB6	0.3916	0.41	407	NB9	0.383	0.397	401	NB2	0.3651	0.3699	/	/	/	/
		0.383	0.397			0.3651	0.3699			0.3585	0.3599			/	/
		0.3935	0.3913			0.3756	0.3642			0.369	0.3542			/	/
		0.4021	0.4043			0.3935	0.3913			0.3756	0.3642			/	/
304	WR5	0.4532	0.4108	305	WR9	0.444	0.4185	301	WR2	0.4344	0.3884	/	/	/	/
		0.444	0.4185			0.4252	0.3961			0.4252	0.3961			/	/
		0.4534	0.4297			0.4344	0.3884			0.4158	0.3849			/	/
		0.4626	0.422			0.4532	0.4108			0.425	0.3772			/	/
212	WA6	0.4752	0.4437	213	WA9	0.4675	0.4345	209	WA3	0.4496	0.4132	/	/	/	/
		0.4675	0.4345			0.4496	0.4132			0.4423	0.4044			/	/
		0.4767	0.4268			0.4588	0.4055			0.4515	0.3967			/	/
		0.4844	0.4360			0.4767	0.4268			0.4588	0.4055			/	/

Note: Tolerance of Color coordinates is ± 0.01 . 颜色坐标 xy 的公差为 ± 0.01 .

Bin Range of Forward Voltage 电压等级代码

Group	Min VF(V)	Max VF(V)	Group	Min VF(V)	Max VF(V)
02	2.7	2.8	06	3.1	3.2
03	2.8	2.9	07	3.2	3.3
04	2.9	3.0	08	3.3	3.4
05	3.0	3.1			

Note: Tolerance of Forward Voltage is $\pm 0.1V$. 正向电压的公差为 $\pm 0.1V$.

Technical Data Sheet

Part Number: MTXB-2835XB-MMA TOP LED, Working Current @ IF = 60mA/150mA

Relative Spectral Power Distribution 相对光谱功率

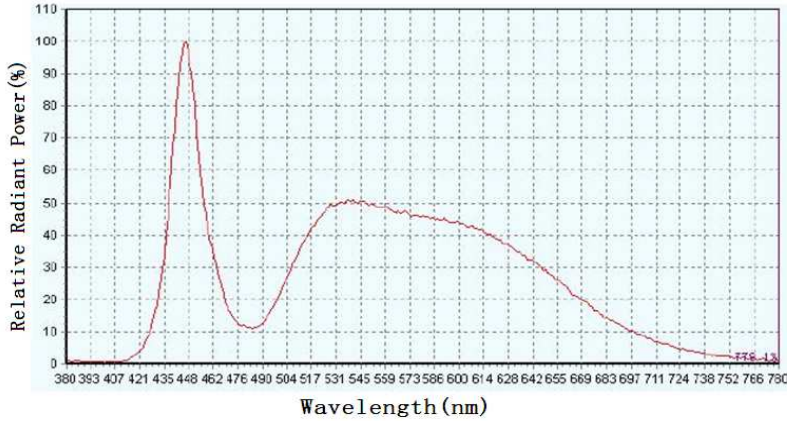

正白光谱图

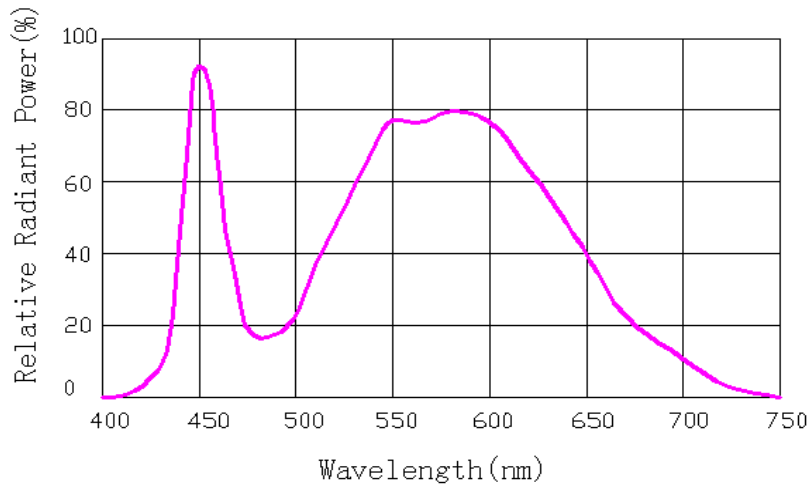

自然白光光谱图

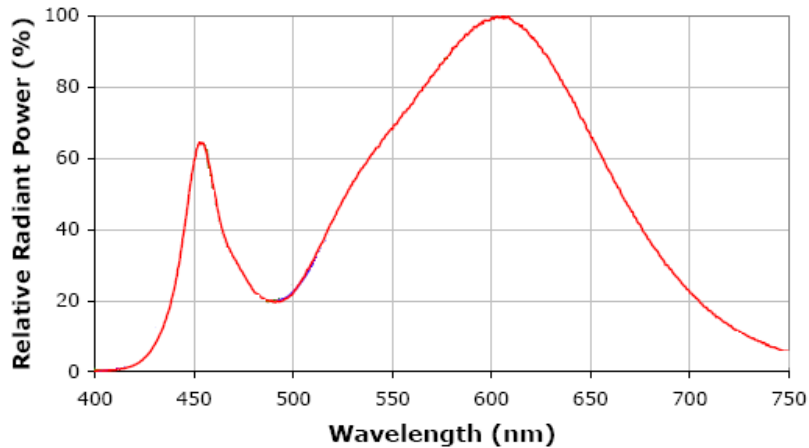

暖白光光谱图

Technical Data Sheet

Part Number: MTXB-2835XB-MMA TOP LED, Working Current @ IF = 60mA/150mA

Electrical Characteristics 电性特征

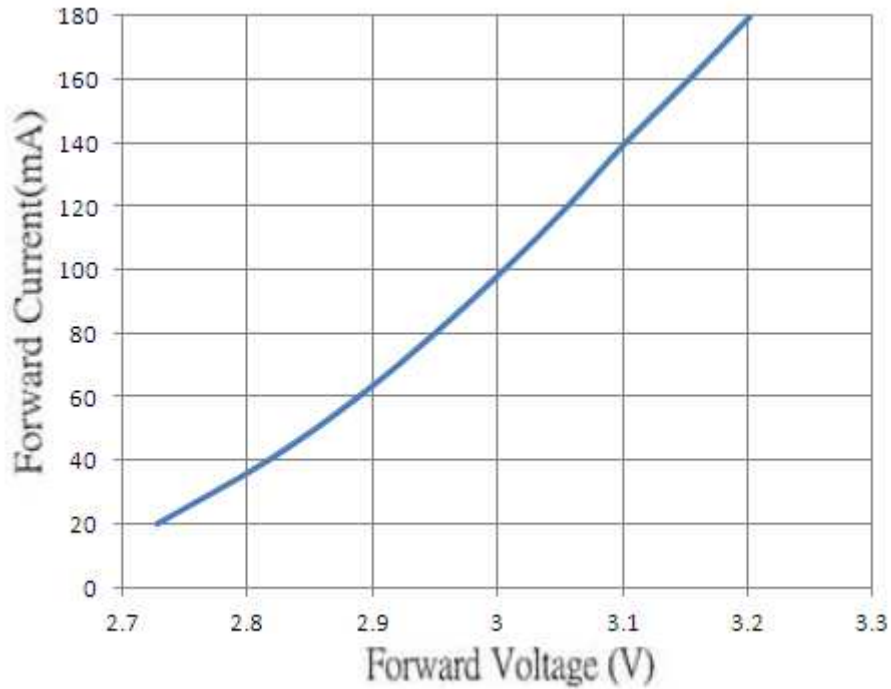

Viewing Angle 发光角度

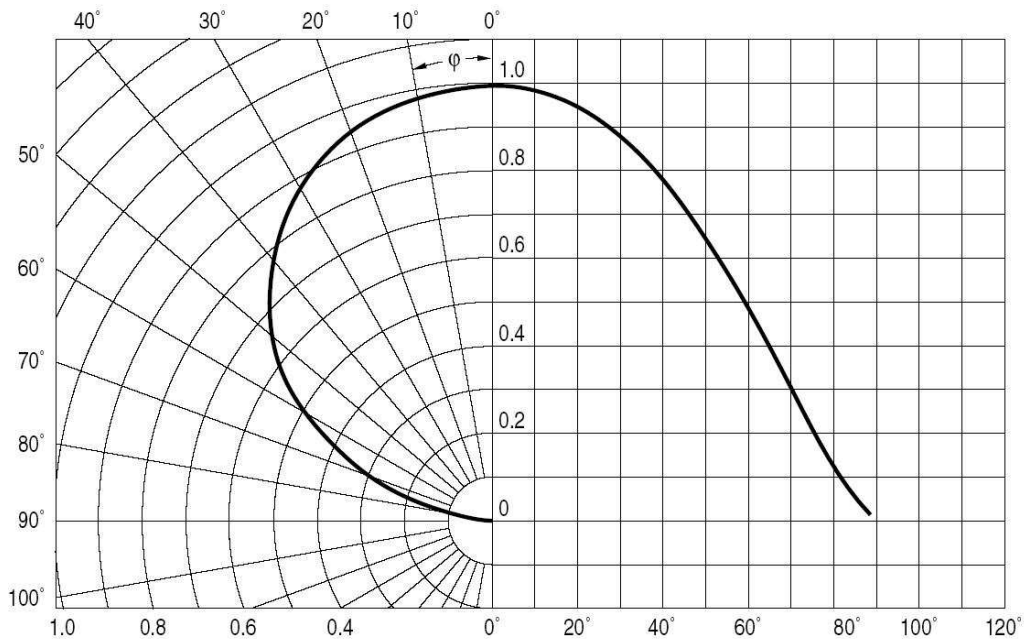

Technical Data Sheet

Part Number: MTXB-2835XB-MMA TOP LED, Working Current @ IF = 60mA /150mA

Guideline for Soldering 焊接指导

Handling of an SMD LED should be done only when the package has been cooled down to below 40°C or less. This is to prevent SMD LED failures due to thermal-mechanical stress during handling.

SMD LED 焊接后, 请将其冷却到 40°C 以下进行操作, 以防止操作过程中因热应力造成 SMD LED 损坏。

1. Hand Soldering 使用烙铁人手焊接

A soldering iron of less than 20W is recommended to be used in Hand Soldering. Please keep the temperature of the soldering iron under 300°C while soldering. Each terminal of the LED is to go for less than 3 second and for one time only.

推荐使用功率低于 20W 的烙铁, 焊接时烙铁的温度必须保持在 300°C 以下, 且每个电极只能进行一次焊接, 每次焊接的持续时间不得超过 3 秒。

Be careful because the damage of the product is often started at the time of the hand soldering.

人手焊接过程中的不慎操作易引起 LED 产品的损坏, 应当小心谨慎。

2. Reflow Soldering 回流焊接

Recommended reflow soldering condition (Lead-free solder)

建议的回流焊条件 (无铅焊锡)

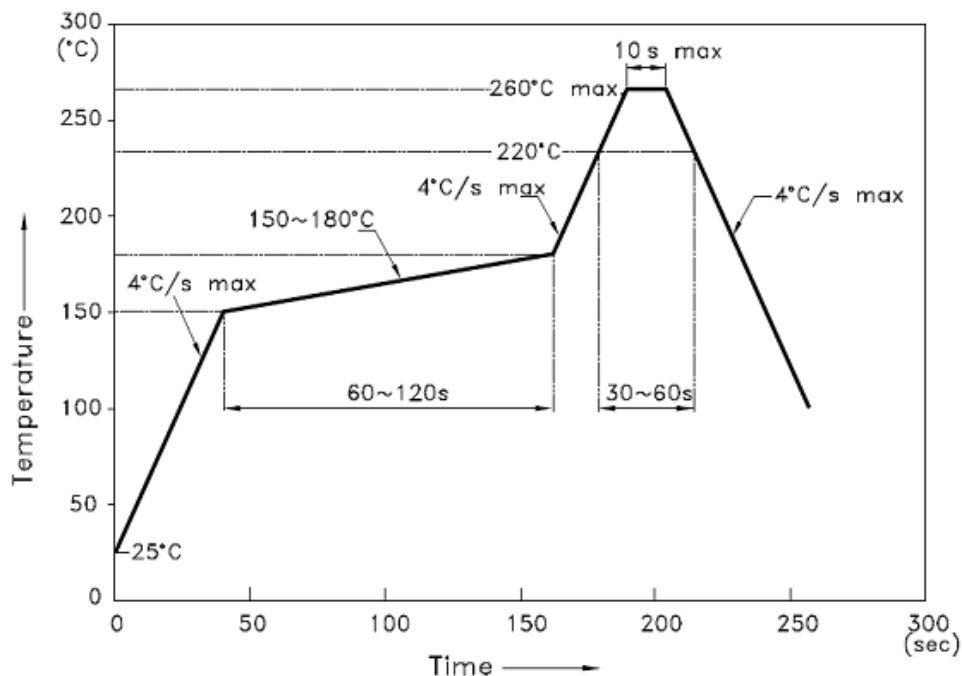

Note: 1. We recommend the reflow temperature 245°C (+/-5°C). The maximum soldering temperature should be limited to 260°C. 建议的回流焊温度 245°C (+/-5°C)。最大的焊接温度需限制在 260°C。

2. Reflow soldering should not be done more than two times. 回流焊次数请勿超过两次。

3. When soldering, do not put stress on the LEDs during heating. 回流焊过程中, 请勿挤压 LED。

Technical Data Sheet

Part Number: MTXB-2835XB-MMA TOP LED, Working Current @ IF = 60mA /150mA

Test items and results of reliability 信赖度测试项目及报告

Test Item	Test conditions	Test Duration	Sample NO.
Solderability 焊锡性	T=260°C±5°C, 5Sec	3Time	0/22
Temperature Cycle 温度循环	-40°C (30min) ~25°C (5min) ~100°C (30min)	100cycles	0/50
High Temperature Storage 高温贮存	Ta=100°C±3°C	1000 hrs	0/50
Low Temperature Storage 低温贮存	Ta=-40°C±3°C	1000 hrs	0/50
Temperature Humidity Storage 高温湿度贮存	Ta=60°C±3°C, RH=90%±3%	1000 hrs	0/50
Life Test 1 寿命试验 1	Ta=25°C±3°C, If=150mA	1000 hrs	0/22
Life Test 2 寿命试验 2	Ta=25°C±3°C, If=180mA	240 hrs	0/22
High Temperature Life Test 高温寿命试验	Ta=60°C±3°C, RH=90%±3%, If=150mA	240 hrs	0/22

CRITERIA FOR JUDGING THE DAMAGE

Item	Symbol	condition	Criteria for Judgment	
			MIN	MAX
Forward Voltage	V _F	I _F =150 mA	-	U _{sl} (1) x 1.2
Luminous Intensity	I _v	I _F =150 mA	LSL(2) x 0.7	-

Note: (1)USL: Upper Standard Level
(2) LSL: Lower Standard Level

Technical Data Sheet

Part Number: MTXB-2835XB-MMA TOP LED, Working Current @ IF = 60mA /150mA

Tape and Reel 载带和卷盘

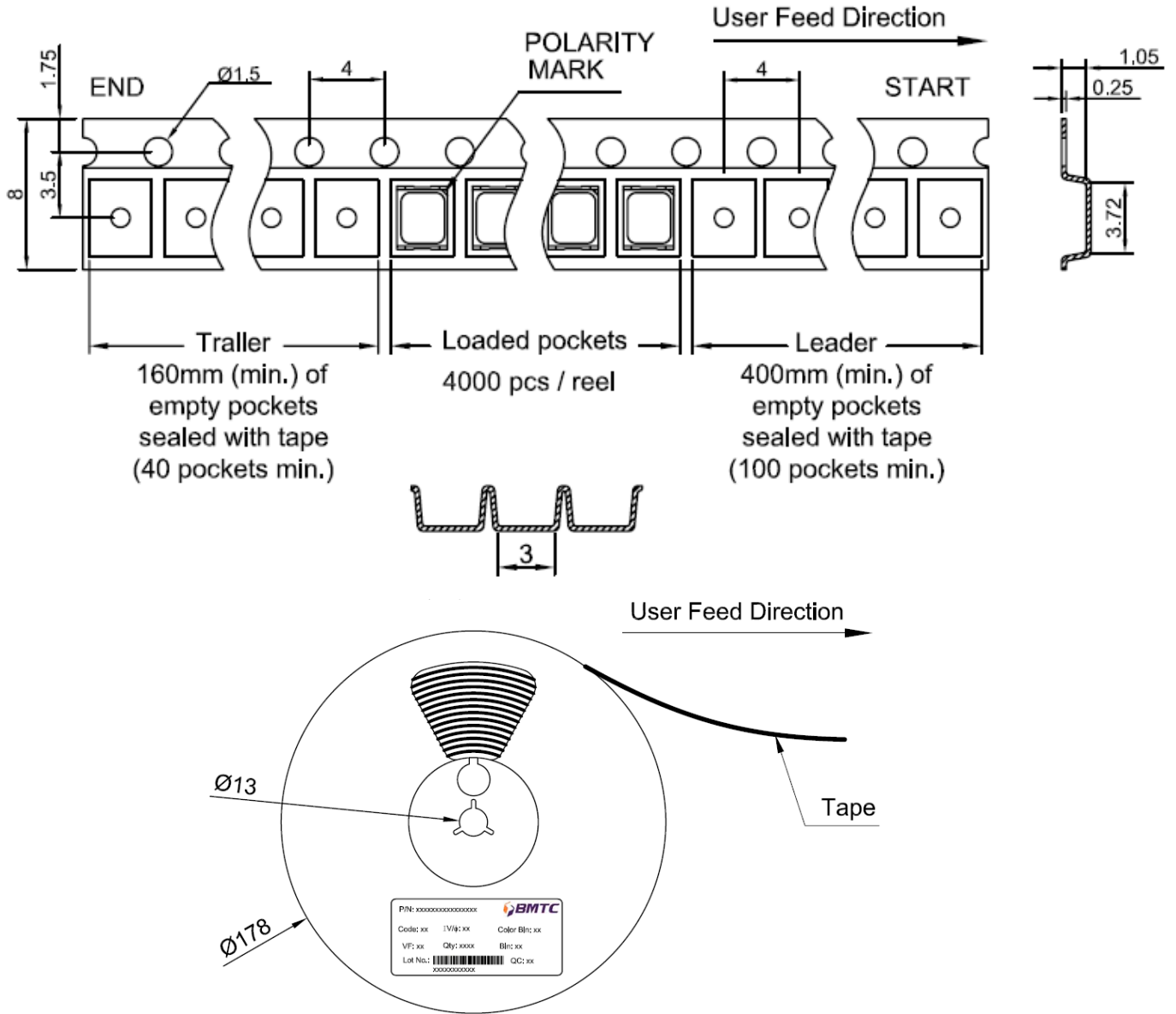

Note:

1. The number of loaded products in the reel is 4000ea. 每卷所载产品数量为 4000pcs。
2. All dimensions are in millimeters (tolerance: ± 0.2). 所有尺寸单位为 mm,公差为 ± 0.2 。
3. Scale: None. 产品比例: 无。

Technical Data Sheet

Part Number: MTXB-2835XB-MMA TOP LED, Working Current @ IF = 60mA/150mA

Dry Packaging and Packaging 干式包装和包装

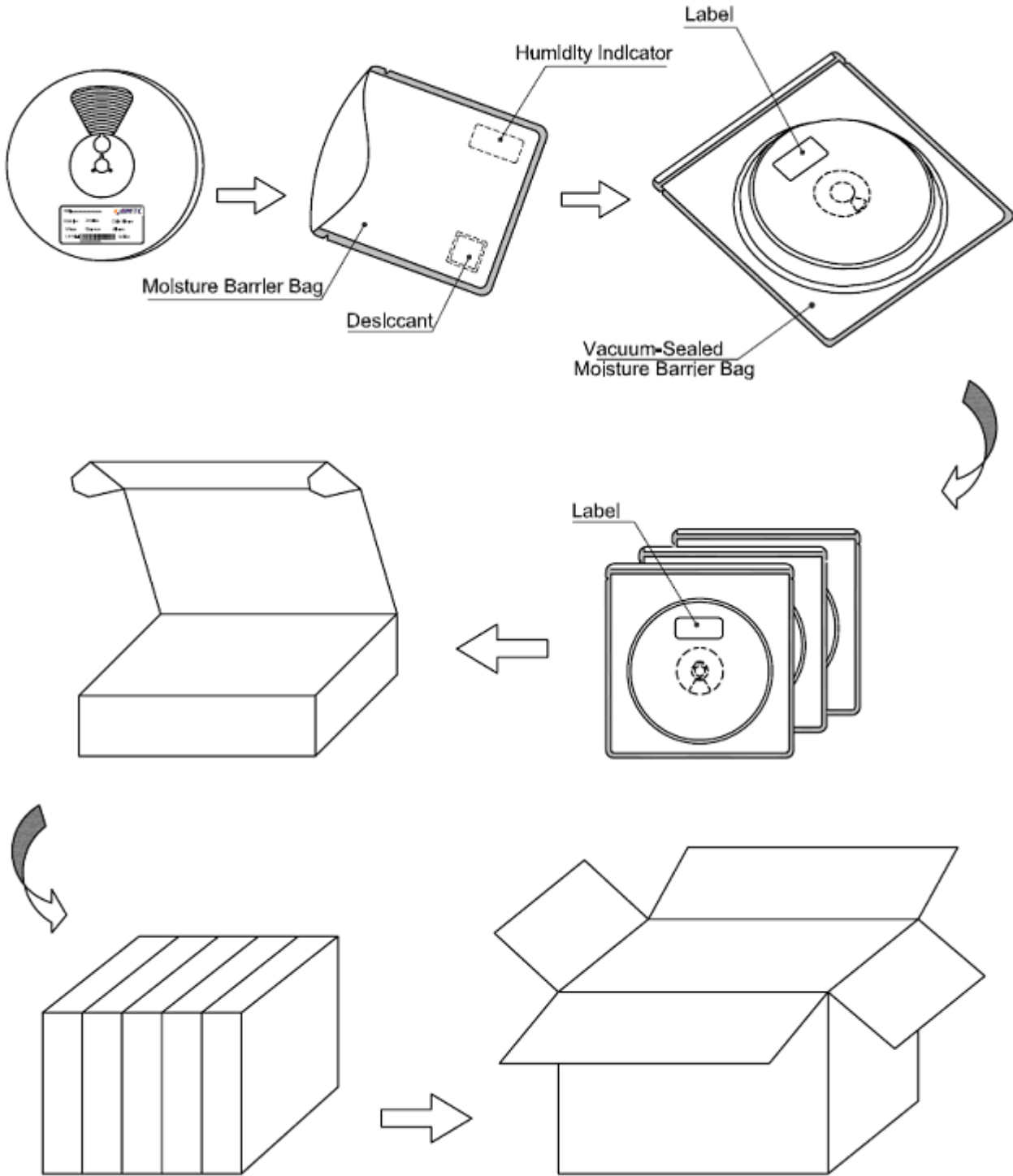

Technical Data Sheet

Part Number: MTXB-2835XB-MMA TOP LED, Working Current @ IF = 60mA/150mA

Test Circuit 测试电路



NOTE: All temperatures refer to the topside of the package, measured on the package body surface.
注：所有温度是指在封装本体上表面测得的温度。

Handling Precautions 处理注意事项

1. Over-current-proof 过电流保护

Customer must apply resistors for protection; otherwise slight voltage shift will cause big current change (Burn out will happen).

客户必须采用电阻进行保护，否则轻微电压漂移将导致电流发生巨大变化(产品将被烧坏)。

2. Cleaning 清洗

2.1 When necessary, cleaning should occur only with isopropyl alcohol (IPA) at room temperature (25°C) for a duration of no more than one minute. Dry at room temperature for 15 minutes before use.

产品如需清洗，只能在室温(25°C)下采用异丙醇(IPA)清洗，清洗时间不超过 1 秒。使用前在室温下放置 15 分钟晾干产品。

2.2 The influence of ultrasonic cleaning on the SMD LED depends on factors such as ultrasonic power and the way the SMD LEDs are mounted. Ultrasonic cleaning should be pre-qualified to ensure this will not cause damage to the SMD LEDs.

超声波清洗对 SMD LED 的影响取决于超声波功率及 SMD LED 的贴装方式等因素。超声波清洗需经过预审合格，以确保此举不会对 SMD LED 造成损害。

Technical Data Sheet

Part Number: MTXB-2835XB-MMA TOP LED, Working Current @ IF = 60mA/150mA

3. Storage 储存

3.1 Don't open moisture proof bag before the products are ready to use.

产品在准备使用之前，请勿打开防潮袋

3.2 Before opening the package: The LEDs should be kept at 30°C or less and 90%RH or less.

防潮袋打开之前：LED应该保存在环境温度30°C(含)以下和相对湿度90%(含)以下的环境

3.3 After opening the package: The LED's floor life is 24 hours under 30°C or less and 70% RH or less. If unused LEDs remain, it should be stored in moisture proof packages.

防潮袋打开之后：在环境温度30°C(含)以下和相对湿度70%(含)以下，LED的使用时间是24小时；未用完的LED需使用防潮袋密封包装

4. Baking 烘烤

It is recommended to bake before soldering when the pack is unsealed after 24hrs. The conditions are as followings:

如包装敞开超过 24 小时，我们建议焊接前对产品进行烘烤。烘烤条件如下：

4.1 65 ± 3°C x (24hrs) and <5%RH, taped reel type 卷带

4.2 100 ± 3°C x (4hrs), bulk type 散装

4.3 130 ± 3°C x (2hrs), bulk type 散装

5. Operating 操作

Compare to epoxy encapsulant that is hard and brittle, silicone is softer and flexible. Although its characteristic significantly reduces thermal stress, it is more susceptible to damage by external mechanical force. As a result, special handling precautions need to be observed during assembly using silicone encapsulated LED products. Failure to comply might leads to damage and premature failure of the LED.

与又硬又脆的环氧封装相比，硅胶更软，更具弹性。尽管它的特性明显降低热应力，但它更易被外界压力破坏。因此，在使用硅胶封装的 LED 产品时，应该留意安装过程中的一些特殊处理事项。不遵守操作的话可能导致 LED 损坏和失效

Technical Data Sheet

Part Number: MTXB-2835XB-MMA TOP LED, Working Current @ IF = 60mA/150mA

5.1 Handle the component along the side surfaces by using forceps or appropriate tools.

用镊子或合适的工具夹在元件的侧边

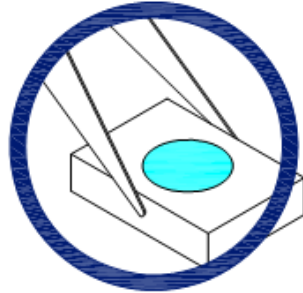

5.2 Do not directly touch or handle the silicone lens surface. It may damage the internal circuitry.

请勿直接触摸或操作硅胶透镜表面，这可能会损坏内部的电路

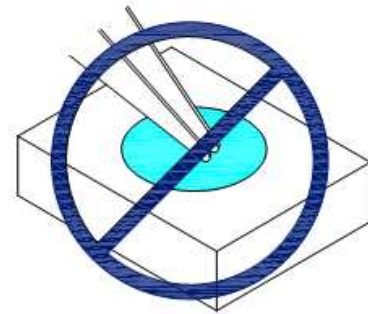

5.3 Do not stack together assembled PCBs containing exposed LEDs. Impact may scratch the silicone lens or damage the internal circuitry.

若 PCB 上已贴装了 LED 且暴露在外，请勿将 PCB 叠成堆。相互间的挤压可能会划伤硅胶透镜表面或损坏内部电路

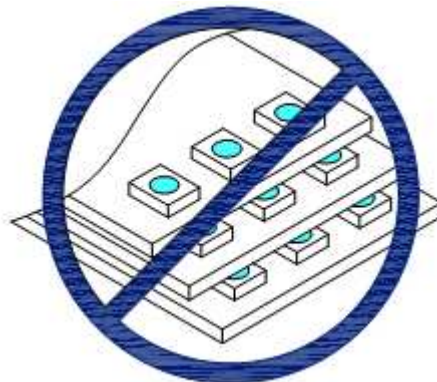

Technical Data Sheet

Part Number: MTXB-2835XB-MMA TOP LED, Working Current @ IF = 60mA /150mA

5.4 The outer diameter of the SMD pickup nozzle should not exceed the size of the LED to prevent air leaks. The inner diameter of the nozzle should be as large as possible.

SMD 吸嘴的外径不应超过 LED 的尺寸以避免漏气。吸嘴的内径应尽可能大

5.5 A pliable material is suggested for the nozzle tip to avoid scratching or damaging the LED surface during pickup.

吸嘴头建议使用柔软的材料以避免 LED 硅胶表面划伤或损坏

5.6 The dimensions of the component must be accurately programmed in the pick-and-place machine to insure precise pickup and avoid damage during production.

元件的尺寸必须在贴片机器上精确地程序化，以确保准确地拾取及避免生产中的损坏

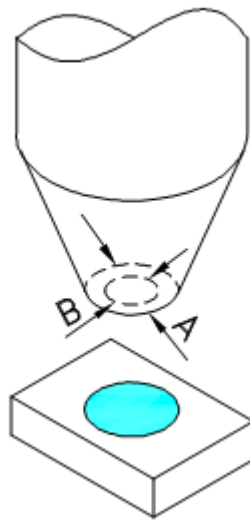

5.7 Users should be cautioned not to stare at the light of this LED product. The bright light can damage the eye.

用户应注意，LED 发光时，请勿直视。LED 的强光可能会伤害您的眼睛。

Technical Data Sheet

Part Number: MTXB-2835XB-MMA TOP LED, Working Current @ IF = 60mA /150mA

Chemicals Tested as Harmful 化学测试中的有害物质

In testing, BMTc has found the following chemicals to be harmful to the LEDs. BMTc recommends not using these chemicals anywhere in an LED system. The fumes from even small amounts of these chemicals may damage the LEDs.

经过测试，BMTc发现下列化学品会对LED造成损害，建议不要在任何的LED系统使用这些化学品。即使这些化学品量很少，其所释放的气体也可能会导致LED损害。

- Chemicals that might outgas aromatic hydrocarbons (e.g., toluene, benzene, xylene)

可能会致使芳香烃化合物释气的化学物（如：甲苯，苯，二甲苯）

- Methyl acetate or ethyl acetate (i.e., nail polish remover)

乙酸甲酯或乙酸乙酯（如：指甲油清洗剂）

- Cyanoacrylates (i.e., Superglue)

氰基丙烯酸酯（如：强力胶）

- Glycol ethers (including Precision Electronics Cleaner - dipropylene glycol monomethyl ether)

乙二醇（包括精密电子清洗剂-二丙二醇单甲醚）

- Formaldehyde or butadiene

甲醛或丁二烯

- bleach

漂白剂

- Cleaner spray

清洁喷雾剂

- activator

活化剂

- thread locker

螺丝固定胶

- Sulfur, bromide, iodine , chloride

硫，溴，碘，氯

Technical Data Sheet

Part Number: MTXB-2835XB-MMA TOP LED, Working Current @ IF = 60mA /150mA

ESD Protection During Production 生产过程中的静电保护

Electric static discharge can result when static-sensitive products come in contact with the operator or other conductors.

当操作人员或者其他导体接触静电敏感材料时，容易产生静电放电。

The following procedures may decrease the possibility of ESD damage:

以下操作可降低静电破坏的可能性

1. Minimize friction between the product and surroundings to avoid static buildup.

将产品和外界之间的摩擦减到最低以避免静电产生

2. All production machinery and test instruments must be electrically grounded.

所有的产品设备和测试仪器必须接地

3. Operators must wear anti-static bracelets.

操作人员必须配戴静电环

4. Wear anti-static suit when entering work areas with conductive machinery.

进入带电设备工作区域时需穿防静电服

5. Set up ESD protection areas using grounded metal plating for component handling.

使用经电镀处理的金属部件接地从而建立 ESD 保护区

6. All workstations that handle IC and ESD-sensitive components must maintain an electrostatic potential of 150V or less.

所有操作 IC 和 ESD 敏感器件元器件的工作台必须保持低于 150V 的静电保护

7. Maintain a humidity level of 50% or higher in production areas.

产品区域环境需保持高于 50%的湿度水平

8. Use anti-static packaging for transport and storage.

运输和储存需使用防静电包装

9. All anti-static equipment and procedures should be periodically inspected and evaluated for proper functionality.

防静电设备及相关操作应该定期检查及评估以确保运行正常

Technical Data Sheet

Part Number: MTXB-2835XB-MMA TOP LED, Working Current @ IF = 60mA /150mA

Thermal Management 热管理

1. Thermal design of the end product is of paramount importance. Please consider the heat generation of the LED when making the system design. The coefficient of temperature increase per input electric power is affected by the thermal resistance of the circuit board and density of LED placement on the board, as well as other components. It is necessary to avoid intense heat generation and operate within the maximum ratings given in this specification.

终端产品的散热设计是极其重要的。在做整体设计时请考虑 LED 的热量处理。单位输入功率的温度系数的增加受线路板的热阻，LED 在板上布置的密度和其他元器件的影响。避免热量积累和在本规格书中指定的最大额定范围内操作是必要的

2. The equation ① indicates correlation between Tj and Ta ,and the equation ② indicates correlation between Tj and Ts

等式①表明 Tj 和 Ta 的相互关系，等式②表明 Tj 和 Ts 的相互关系

$$T_j = T_a + R_{thj-a} * W \quad \text{.....} \quad \text{①}$$

$$T_j = T_s + R_{thj-s} * W \quad \text{.....} \quad \text{②}$$

Tj = dice junction temperature: °C Tj = 晶片结点温度: °C

Ta = ambient temperature: °C Ta = 环境温度: °C

Ts = solder point temperature: °C Ts= 焊接点温度: °C

Rthj-a = heat resistance from dice junction temperature to ambient temperature : °C / W

Rthj-a=晶片结温至环境温度之间的热阻: °C/W

Rthj-s = heat resistance from dice junction temperature to Ts measuring point : °C / W

Rthj-s=晶片结温至 Ts 测量点之间的热阻: °C/W

W = inputting power (IFx VF) : W

W=输入功率 (IFx VF) : W

Technical Data Sheet

Part Number: MTXB-2835XB-MMA TOP LED, Working Current @ IF = 60mA/150mA

Humidity Indicator Card 湿度卡

After the moisture barrier bag is opened, make sure that Humidity Indicator Card does not become red at 30%RH. Otherwise, Devices require baking again under below conditions.

65 ± 3°C x (24hrs) and <5%RH, taped reel type

防潮袋开封后，应立即确认湿度卡 30%处是否变成淡红色，若 30%处开始变成淡红色，该包产品需要在如下条件下重新烘烤：

65 ± 3°C x (24hrs) and <5%RH, 卷带

